



Round balers

VARIANT

585 580 565 560



# Cool under pressure – the VARIANT from CLAAS.



## SMART DENSITY



Smart baling system: To ensure the desired bale density, the new compaction manager controls both tensioning arms independently of each other.

## 6 seconds



is all the time the VARIANT needs to discharge the bale onto the field: from the time the tailgate opens until it closes again.

## 360° rotor



– for direct baling start in all crop types, with an impeccable bale shape.

## 14 or 17 knives



– make the VARIANT with ROTO CUT the ideal baler for short chopping, and ensure outstanding feed quality.

## 3 m/s



– the bale rotation speed enables the precisely operating wrapping system to produce firm bales that keep their shape.

<b>VARIANT from CLAAS</b>	<b>2</b>
The world of CLAAS	4
Model overview	6
Forage quality   Safety	10
Output   Driving experience	12
Bale chamber	14
<b>Technology</b>	<b>16</b>
Pick-up and crop flow	18
Rotor and ROTO FEED	20
ROTO CUT and ROTO CUT HD	22
PRO lowerable floor and early warning system	24
Wrapping + tying	26
Tailgate	30
<b>Operation</b>	<b>32</b>
<b>Maintenance</b>	<b>36</b>
<b>CLAAS Service &amp; Parts</b>	<b>38</b>
<b>Safety</b>	<b>40</b>
<b>Specifications</b>	<b>42</b>

Unique technology for compact bales – CLAAS balers.

A baler has to do more than just bale hay and straw. Today's farms have a wide range of requirements in terms of bale size and format, and how the bales are going to be used. CLAAS meets these requirements with the QUADRANT range of square balers and the ROLLANT and VARIANT round balers. The end result is compact bales, an impeccable bale shape and advanced technology.

The VARIANT round baler is a real workhorse. It impresses with high productivity, a long service life and ease of operation – and with some smart ideas, which may not completely eliminate the hard work involved, but certainly make it much easier.



VARIANT		585 RC PRO	565 RC PRO	580 RF / RC	560 RF / RC
Bale width	m	1.20	1.20	1.20	1.20
Diameter	m	0.90 to 1.80	0.90 to 1.60	0.90 to 1.80	0.90 to 1.60
Pick-up width	m	2.10 or 2.35	2.10 or 2.35	2.10 or 2.35	2.10 or 2.35
HD drive		●	●	–	–
Crop feed system		RC HD (17 knives)	RC HD (17 knives)	RC (14 knives) / RF	RC (14 knives) / RF
Number of driven rollers		2	2	2	2

● Standard ○ Optional – Unavailable

In a large family, everyone can play to their strengths.

In addition to their individual strengths, all VARIANT models have these decisive advantages in common:

- SMART DENSITY for an ideal bale shape
- SMART DENSITY for a soft core in hay
- SMART DENSITY for belt reliability
- High baling weight
- 100% bale start under any harvesting condition thanks to the active rotor
- Variably adjustable bale diameters (1.60 m or 1.80 m)
- Innovative soft core device according to individual requirements
- New patented wrapping and tying process using a new intake plate with CLAAS Covered or CLAAS Covered XW wrapping
- Bale discharge within 6 seconds
- Optimal crop flow from the pick-up to the rotor
- ISOBUS interface as standard

VARIANT	585 / 565	580 / 560
1 Cam-controlled pick-up with 2.10 m working width DIN 11220	<input type="checkbox"/>	<input type="checkbox"/>
2 Cam-controlled pick-up with 2.35 m working width DIN 11220	<input type="checkbox"/>	<input type="checkbox"/>
3 Roller crop press	<input type="checkbox"/>	<input type="checkbox"/>
4 Double roller crop press	<input type="checkbox"/>	<input type="checkbox"/>
5 Oscillating or folding oscillating castor guide wheels	<input type="checkbox"/>	<input type="checkbox"/>
6 Exclusive to CLAAS: active high-power rotor with forced baling start	<input type="checkbox"/>	<input type="checkbox"/>
7 ROTO CUT: 360° cutting rotor with 14 knives	<input type="checkbox"/>	<input type="checkbox"/>
7.1 ROTO CUT HD: new 360° cutting rotor with 17 knives	<input type="checkbox"/>	<input type="checkbox"/>
8 ROTO FEED: helical rotor for an even crop flow	<input type="checkbox"/>	<input type="checkbox"/>
9 Heavy-duty drive: reinforced chains and rotor	<input type="checkbox"/>	<input type="checkbox"/>
10 Drop PRO cutting frame	<input type="checkbox"/>	<input type="checkbox"/>
11 High drive torque with a belt speed of approx. 3 m/s	<input type="checkbox"/>	<input type="checkbox"/>
12 4 reliable, high-strength endless belts	<input type="checkbox"/>	<input type="checkbox"/>
13 Fast comfort net wrapping	<input type="checkbox"/>	<input type="checkbox"/>
14 XW net wrapping	<input type="checkbox"/>	<input type="checkbox"/>
15 New net wrapping for ergonomic access, intake plate for twine tying and net wrapping	<input type="checkbox"/>	<input type="checkbox"/>
16 SMART DENSITY with active hydraulics and double tensioning arm	<input type="checkbox"/>	<input type="checkbox"/>
17 Bale size and soft core diameter can be adjusted from the cabin	<input type="checkbox"/>	<input type="checkbox"/>
18 Bale pressure and soft core pressure can be controlled from the cab	<input type="checkbox"/>	<input type="checkbox"/>
19 Fast tailgate: bale discharge within 6 s	<input type="checkbox"/>	<input type="checkbox"/>
20 CEMIS 700	<input type="checkbox"/>	<input type="checkbox"/>
21 Large tyres up to 22.5"	<input type="checkbox"/>	<input type="checkbox"/>
22 7.2 l lubricating capacity	<input type="checkbox"/>	<input type="checkbox"/>
23 Automatic electric central lubrication system	<input type="checkbox"/>	<input type="checkbox"/>

Available -  Unavailable

## VARIANT 585 / 565 The workhorse.



- Individual strengths:
- ROTO CUT: new 360° cutting rotor with 17 knives
  - Heavy-duty concept: reinforced chains, special knife guard and particularly robust 8-mm rotor
  - Perfect for baling silage
  - SMART DENSITY: intelligent baling for an ideal bale shape, density and soft core
  - PRO cutting frame with integrated early warning system as standard



## VARIANT 580 / 560 The all-rounder.

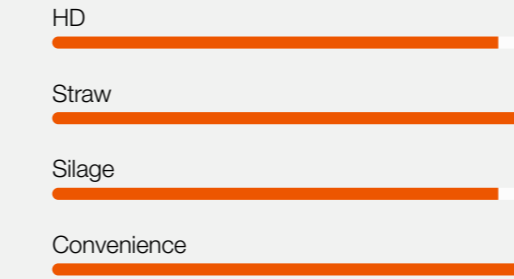

- Individual strengths:
- ROTO CUT: new 360° 6-mm cutting rotor with 14 knives
  - ROTO FEED: even crop flow thanks to the helical rotor
  - Easily operated by any driver
  - Impressive versatility: ideal for silage, hay or straw
  - SMART DENSITY: baling intelligence for an ideal bale shape, density and soft core



More versatile than ever.



# VARIANT.

Hard shell, soft core.



## Forage quality.

The VARIANT produces perfectly compacted bales with a soft core for optimum forage quality.

### Superior forage quality.

- High-quality hay
- High baling densities with straw
- Even layers and bale shape for perfect silage
- Easy ventilation for drying hay
- Excellent cutting quality for a better fermentation process and easy distribution
- Faster preparation of rations in the feed mixer



360°, 8-mm cutting rotor with 17 knives.  
Page 23



NEW

Soft core for good hay ventilation.  
Page 14

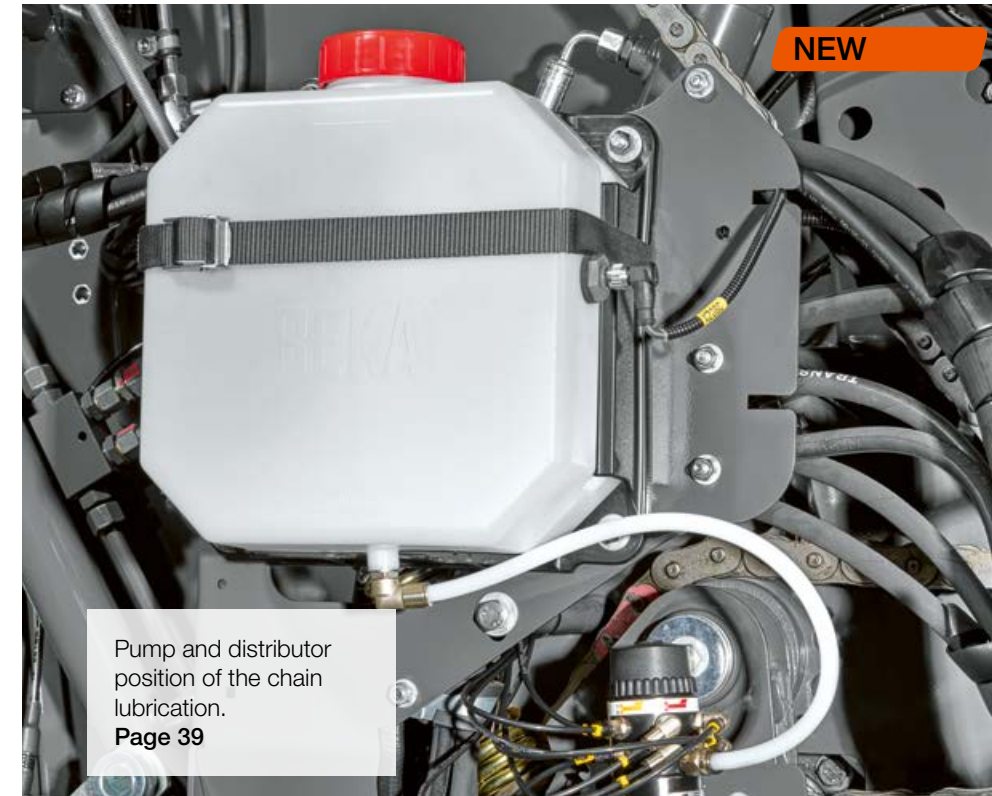

NEW

Pump and distributor position of the chain lubrication.  
Page 39



Extra-wide wrapping/tying for perfect bales.  
Page 29

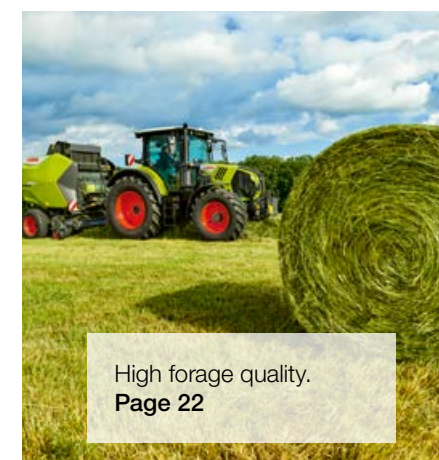

High forage quality.  
Page 22

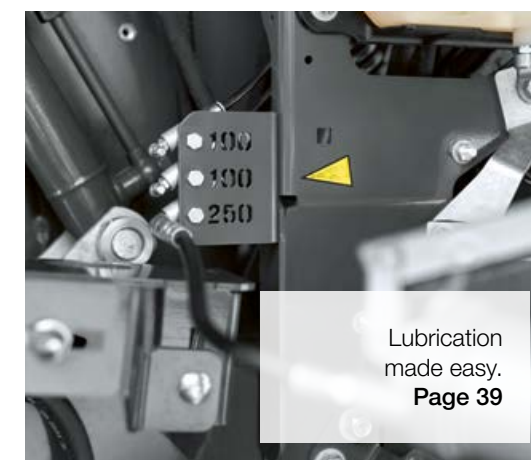

Lubrication made easy.  
Page 39



## Operational reliability and sustainability.

The new net wrapping system with brake is very easy to handle thanks to its lowered position. Plus it can be adjusted from outside the cab.

### Durable and robust.

- 7.2-l oil tank for long working days
- NEW: pump technology for durability and low maintenance costs
- Adjustable oil quantity per distributor
- NEW: lubrication distributor for faster maintenance



Performance.

Delivering high performance is a strength of the VARIANT. Fast wrapping/tying within 6 seconds combined with high tailgate opening and closing speeds delivers high throughputs and reduces downtimes. Moreover, the special active rotor from CLAAS ensures a 100% bale start so you can run the VARIANT continuously at maximum speed.

Full capacity utilisation.

- Extended tyre range for any conditions
- Lowerable PRO cutting frame with early warning system for safe use
- Rapid opening and closing of the tailgate in only 6 seconds

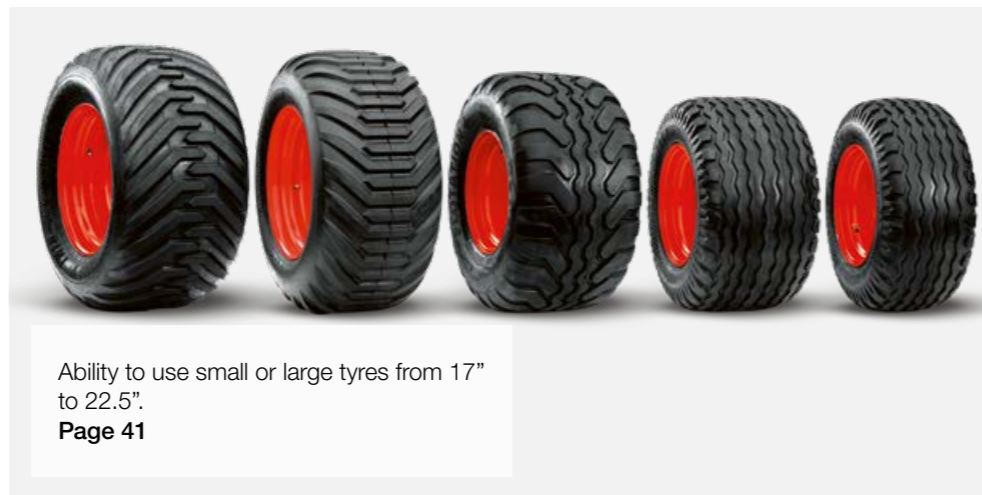

Ability to use small or large tyres from 17" to 22.5".  
Page 41

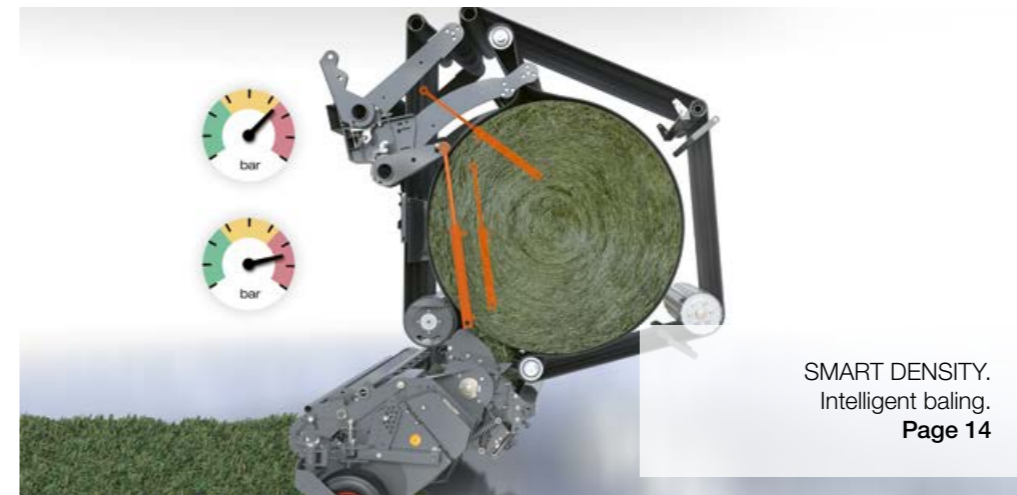

SMART DENSITY.  
Intelligent baling.  
Page 14

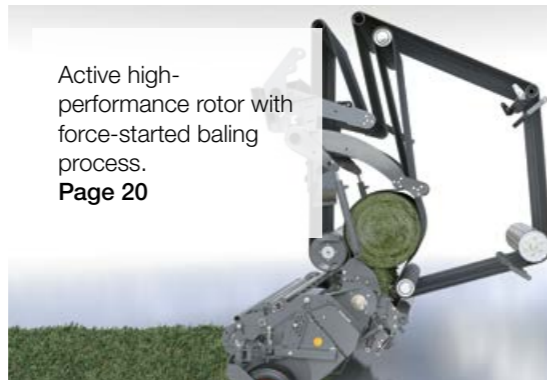

Active high-performance rotor with force-started baling process.  
Page 20



Lowerable PRO cutting frame. For more power and fewer blockages.  
Page 24



CEMIS 700. Access to all key functions directly from the driver's seat.  
Page 32

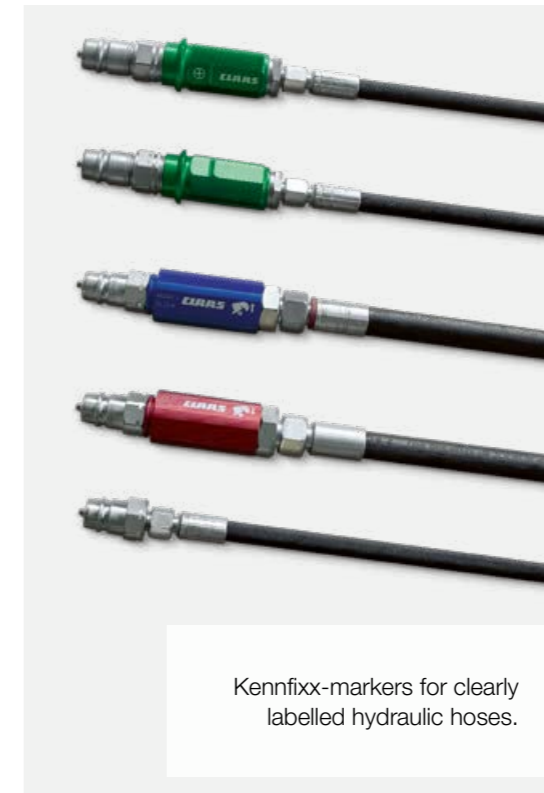

Kennfix-markers for clearly labelled hydraulic hoses.

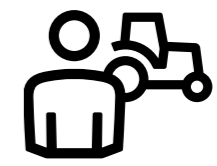

Driving experience.

The new VARIANT supports you in every operation with a high level of comfort. The new SMART DENSITY technology makes it even easier to set and select parameters so that you can bale without any problems in all conditions.

Easy to use.

- The 7" CEMIS 700 is intuitive to operate via a touchscreen, keys or a rotary pushbutton
- Easy handling of net wrapping due to the new position
- New net wrapping with a new net brake
- Very fast wrapping/tying – the bale is discharged after a mere 6 seconds



Bale discharge within 6 seconds.  
Page 30



Roll changes are a breeze.  
Page 28

## SMART DENSITY.

The bale chamber with dual tensioning arm system.

Maximum performance in the bale chamber. The hydraulic bale density control system has been specially developed for maximum compaction in all conditions. The active hydraulic system combines three hydraulic cylinders with a double tensioning arm system to provide actively controlled guidance and smooth operation.

New compaction management.

SMART DENSITY provides fully automatic baler control depending on the individually set crop.

Thanks to the intelligent SMART DENSITY baling system, both tensioning arms are controlled independently to ensure that the optimum belt tension is maintained throughout – for smooth and safe machine operation.

**SMART DENSITY.**

- Optimal belt tension
- Optimal belt guide
- Optimal bale shape under any conditions
- Soft core for optimal bale ventilation, especially with hay
- Always the right pressure for forage, speed and humidity
- Fast response of both tensioning arms

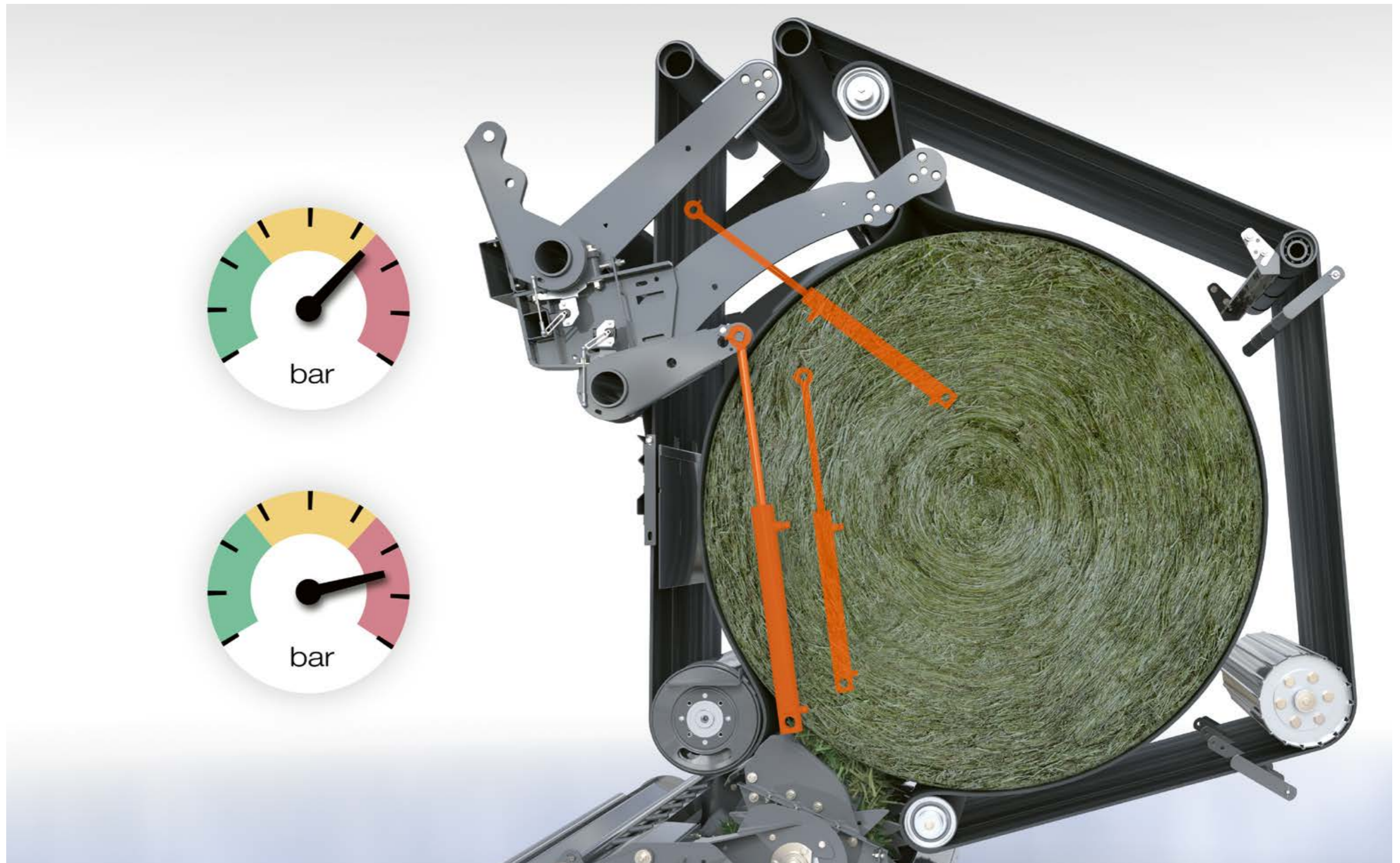

This is how SMART DENSITY works.



A view to high speeds.

You have an excellent view of the pick-up throughout your work, and you can even increase the speed if necessary. Depending on the crop and crop flow, you can push this machine to its limits for maximum performance.





Permanently hungry –  
leaving nothing behind.

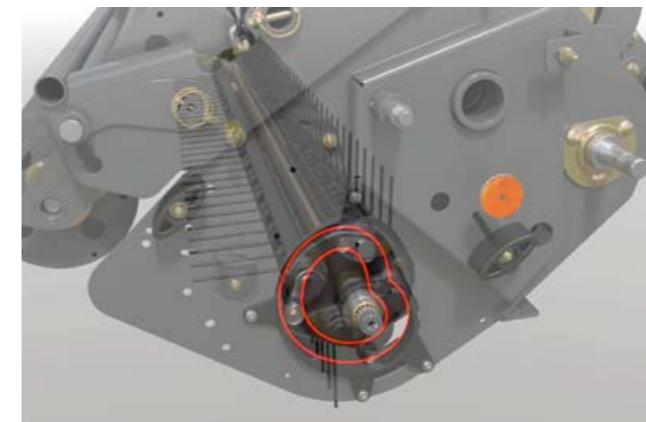

### Cam-controlled pick-up.

The VARIANT was the first round baler with a 2.10-m pick-up, and its vast pick-up capacities and exceptional performance data are still impressive today. The working height of the pick-up can be adjusted without tools. The smart pick-up control is particularly important. It improves the crop flow, especially with short crops, and significantly increases the service life. The VARIANT 585 / 565 and 580 / 560 can even be equipped with a 2.35 m pick-up.



### Double roller crop press.

Proven thousands of times over, and continuously optimised: The front-mounted double roller crop press, available as optional equipment. It compacts the crop perfectly, speeds up the crop flow and ensures active feeding of the crop to the rotor.



### Castor guide wheels.

For all working widths, the pick-up's large castor guide wheels provide uniform suspension and keep the machine on track at all times. This means optimum ground contour following and protects the grass cover even at high speeds and around curves. All models feature tool-free guide wheel height adjustment. The new folding mechanism provides increased convenience, since the guide wheels no longer need to be removed for travel on the road. The folding mechanism is available as optional equipment.

### At a glance.

- High intake capacity: cam-controlled pick-up, widths of 2.10 m or 2.35 m
- Castor guide wheels – optionally folding – to keep the pick-up on track
- Perfect crop flow, thanks to the optimised double roller crop press
- Clear view of the pick-up for a high work rate



This is how the pick-up works.

Once again, everything revolves around just one thing. The rotor and ROTO FEED.

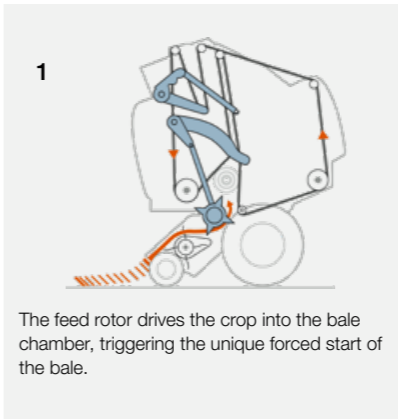

**Real core competence:**  
The rotor starts the bale.

Only from CLAAS: The belts and cutting rotor rotate in opposite directions. The bale is therefore started immediately, creating a firm core. The fast-turning rotor engages directly with the bale and ensures its forced start – with every bale and under all conditions. This also prevents the belts from slipping. You'll feel these advantages every minute you operate the machine. Because you can always drive the VARIANT at full speed.

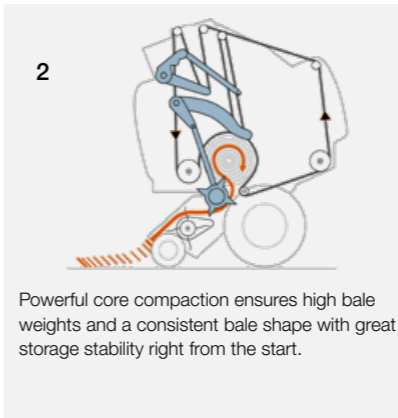

**Core compaction on demand.**

You can set the desired core compaction in terms of the feed quality required and control this parameter conveniently from the cab – for example, maximum core compaction with straw, or a soft core with hay. You can also choose between three default settings, or use two freely adjustable parameters.

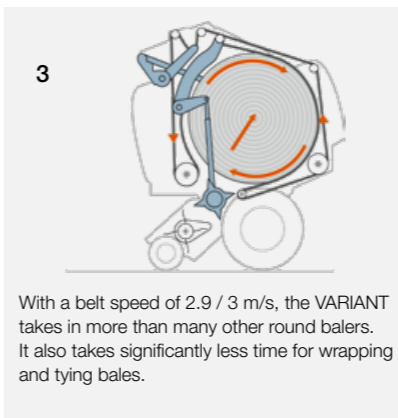

**Uniform filling of the bale chamber.**

The feed rotor, fitted as standard equipment, ensures completely uniform filling of the bale chamber. As a result, this machine bales significantly higher volumes per unit of time, allowing you to operate the VARIANT at incredibly high work rates.

**At a glance.**

- Solid to the core: The rotor gets the bale turning
- Core compaction can be adjusted from the cab as required
- The rotor fills the bale chamber more evenly and therefore processes more baling material

This is how the rotor works.

What 360° means for us – constant bale rotation without any spinning.



NEW: the 360° tine arrangement.

To improve the bale shape even further, the tine arrangement has been optimised in the VARIANT with ROTO FEED. The tines are now arranged helically over 360° so that even short material and small swaths can be distributed very well.



A perfect cut with ROTO CUT for the VARIANT 580 and 560.

14 knives for first-class feed quality. The VARIANT ROTO CUT with its 6-mm-thick, four-star dual tines works more precisely, more effectively and faster than other balers.

- 360° 6-mm tine stars
- Helical tine arrangement (360°)
- Four-star rotor for a short chop
- Precise, short-cut feed portions for greater compaction and easier unwinding
- 14 aggressive knives
- Individually secured, double-tempered steel knives
- Hydraulic knife engagement
- Combined stripper system between and within the dual tines
- Significant time savings when mixing stock feed, and higher milk yields, thanks to top-quality feed



At a glance.

- Better bale shape, thanks to 360° cutting rotor with helical tine arrangement
- ROTO CUT with 6-mm-thick, four-star dual tines
- ROTO CUT Heavy-Duty with 8-mm-thick rotor blades tailored to silage

VARIANT	585	565	580	560
ROTO FEED	-	-	□	□
ROTO CUT (6 mm)	-	-	□	□
ROTO CUT HD (8 mm)	□	□	-	-

□ Available - Unavailable

When endurance matters: ROTO CUT Heavy Duty.

The heavy-duty drive concept in the VARIANT 585 and 565 models makes these machines ideal for tough working conditions in silage. This is because of the 8-mm-thick, four-star dual tines, the ultra-robust individual knife guard and knife bracket. Cutting quality therefore remains excellent even in silage.

**ROTO CUT 360°, 8-mm tine stars.**

- Reinforced individual blade protection
- Reinforced Tsubaki chains (main drive and rotor drive)
- Silage kit
- Four-star rotor for a short chop

It's not just sports cars that can be set lower to the ground.

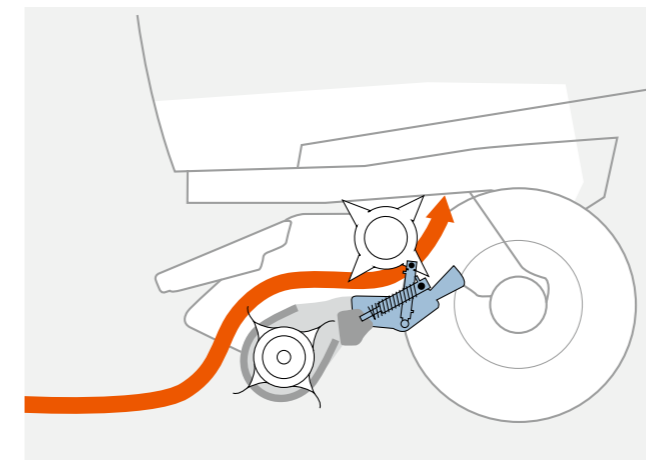

Finding the right level: PRO hydraulically lowerable floor.

Baling forage is a tough job, and it also has to be done fast and efficiently. High daily work rates are essential, and these can only be achieved with intelligent systems that support the driver – such as a lowerable floor that actively adjusts to the crop flow. With automatic lowering by up to 30 mm, a consistent crop feed can be maintained even with variable swaths, without compromising on the high cutting quality. The lowerable floor, which is operated via two hydraulic rams, turns your VARIANT with ROTO FEED or ROTO CUT into a VARIANT PRO.

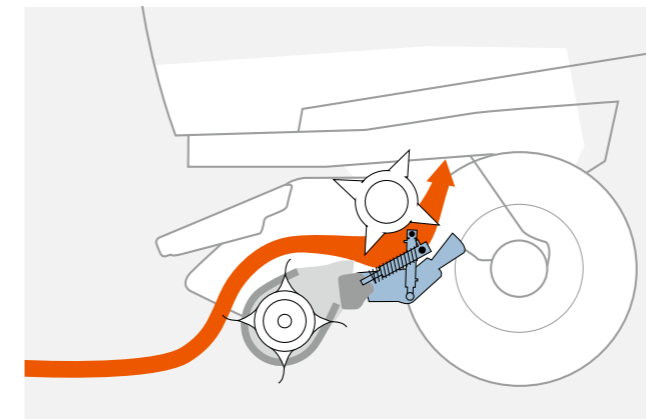

Work at full capacity thanks to the early warning system.

Any unusual floor movement is detected by a sensor and immediately displayed on the control terminal as an optical and acoustic alert. This enables you to respond promptly to any risk of blockage from the driver's seat. As a result you can operate the baler right up to its limits.

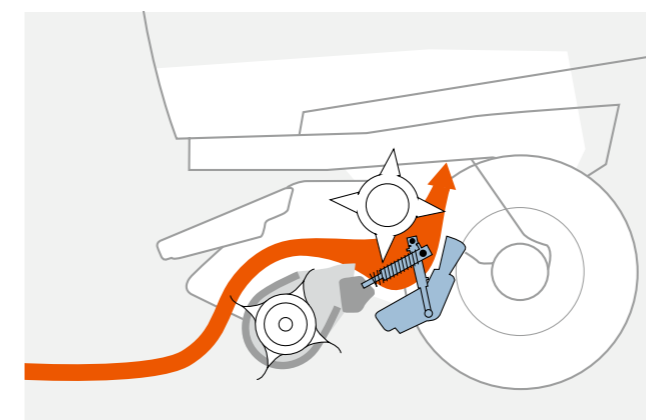

Clear blockages at the touch of a button.

Blockages can be cleared from the control terminal, without needing to leave the tractor cab. The lowerable floor opens, and the rotor pushes the blockage material directly into the bale chamber. In machines with a cutting rotor, you shut off the knife pressure via a pushbutton control before the lowerable floor opens up. When the floor closes again, the knives automatically pivot back into position.

At a glance.

- PRO hydraulically lowerable floor for continuous crop flow and high chop quality
- Early warning system for imminent blockages
- Blockages can be cleared from the comfort of the cab

VARIANT	585	565	580	560
Lowerable PRO floor	□	□	□	□

□ Available – Unavailable

Effective wrapping and tying means two things above all: firmness and reliability.



#### The patented intake plate.

Developed and patented by CLAAS: The new intake plate works in two stages and ensures even more reliable bale wrapping and tying. During baling, the plate stays open to prevent any accumulation of forage. During wrapping and tying, however, the plate is closed so that the net or twine is precisely guided. The result: a highly reliable wrapping and tying system – and very satisfied drivers.

#### Fully automatic start of wrapping and tying.

Both net wrapping and 2-twine tying are started fully automatically. The VARIANT offers plenty of storage space for the work materials you need. You have a choice of storing two net rolls or up to ten reels of yarn.

#### Fast and precise: twine tying.

The VARIANT impresses in field use, not only with net wrapping but also with 2-twine tying. After a fully automatic start, the easily adjustable, highly precise tying system ties firm bales with excellent shape retention. And it does so at a record speed of 3 m/s.

#### Compact, wrap/tie, move straight on to the next bale.

Round baler systems always require the machine to be stopped briefly for wrapping or tying. But the VARIANT has a decisive advantage: Wrapping and tying starts automatically as soon as the desired bale diameter has been reached. Thanks to its high belt speed of up to 3 m/s, this process is particularly fast. This means that baling can continue immediately without any substantial loss of time.

#### At a glance.

- Fast wrapping and tying thanks to a high belt speed (from 5 seconds per bale)
- More precise twine tying or net wrapping, thanks to a new intake plate
- Save time with the automatic start of the wrapping system
- Twine tying for firm bales that will hold their shape

This is how wrapping and tying works.



Scan me.



At a glance.

- Cleanly shaped bales with the new CLAAS Covered net wrapping
- Perfect overview, cleaning and maintenance, thanks to the wide-opening cover
- New CLAAS Covered XW net wrapping for perfect bales right to the edge
- Superior quality: ORIGINAL CLAAS BALETEX twine and CLAAS ROLLATEX PRO net



Precise net wrapping.

The net is always safely wrapped across the full bale width thanks to the helical stretching device. This results in precise net coverage up to the bale edge, even with "normal" netting. And with the XW net, even beyond the edge.

NEW: variator net brake.

The controlled net brake automatically increases the braking effect as the net roll gets smaller to maintain an evenly pre-tensioned net right to the end of the roll. This ensures clean wrapping from the first bale to the last. An adjustable variator causes the rubber roller to rotate more slowly and thus pre-stretches the net.

Standard: CLAAS Covered XW net wrapping.

Whether hay, straw or silage – with the optional extra-wide wrapping you get perfectly shaped bales with excellent shape retention. The helical rollers of the VARIANT ensure optimum overlap at the bale edges for reliable protection. The ideal wrapping material: the extra-wide ROLLATEX PRO XW net roll with 1.30 m width.



Clear view of the wrapping operation.

To enable you to keep an eye on the wrapping operation, and make sure things are happening where and when they should, the wrapping system remains clearly visible at all times, as you have come to expect from CLAAS balers. The wide-opening inspection cover allows easy cleaning and servicing.

Net and twine for professionals.

Maximum wrapping/tying and operational reliability with the ORIGINAL CLAAS BALETEX baling twine and the CLAAS ROLLATEX PRO net for clean edge coverage. CLAAS Covered XW wrapping uses the ROLLATEX PRO XW net with 1.30 m width.



The new net wrapping system in the VARIANT 500 series is positioned 25 cm lower to allow easy cleaning of the net roll under the net brake.

We only wait for a bus.

Tailgate opening and closing.

- 30% faster opening and closing times thanks to a hydraulic block
- Rapid opening and closing of in only 6 seconds
- Less waiting time means a higher area output

This is how the tailgate works.



What should hard work be like?  
Easy as child's play.

Machine operation.

However much you enjoy your work, it shouldn't fill every hour of every day. So every day we do our best to ease your workload, with good ideas, robust equipment and innovative technology. User-friendly, convenient operation and comfort are always our number one focus.





# A new terminal for even greater comfort: CEMIS 700.



The new CEMIS 700 control terminal offers not only a convenient user interface and touchscreen, but also a large display area and very high resolution. The terminal is compatible with various camera systems.

The job counter with 20 storage spaces collects valuable data on the number of bales and operating hours. Naturally the CEMIS 700 is also ISOBUS-compatible and complies with AEF standards.

## CEBIS Touch.

CLAAS tractors with CEBIS Touch control unit are also ISOBUS-compatible. The integrated ISOBUS implement control allows all functions to be displayed and operated. Up to ten ISOBUS functions can be activated and deactivated via function buttons on the CMOTION in the tractor.



## Operation via rotary pushbutton.

The CEMIS 700 offers three different approaches to controlling the unit. Operation via the rotary pushbutton is particularly well suited for jumping between different menu structures.



## Touchscreen operation.

If you want to select a function directly, you'll appreciate the touch function on the CEMIS 700. Simply press the 7" touchscreen to select the required function immediately.



## Operation via keys.

If you have come to appreciate controlling your machine via keys on the CLAAS control units, you can also enjoy this functionality with the CEMIS 700. Many drivers are familiar with thumb controls, which are also particularly user-friendly in the field.

No rest, no rust.  
Chain lubrication for a long service life.



Central lubrication of the tailgate bearings.

To simplify machine maintenance, the various grease nipples for the tailgate rollers are easily accessible from the right-hand side of the machine at a convenient working height.

Electric central lubrication.

Lubrication intervals can be set directly on the operating terminal to ensure that bearings are lubricated automatically.

Constant chain lubrication.

The new distribution units in the 7.2-l lubrication system supply each individual chain with exactly the amount of oil needed for long and smooth-running operation. As a result, you save on cash, in addition to valuable maintenance time.

Thanks to its large opening, the oil tank is easy to fill. Permanent and precise lubrication via wide brushes can be adjusted via an eccentric. An intake filter prevents contamination and blockages of the system. This results in a long reach and easy maintenance, which extend the service life of the chains and deliver another benefit for you.

At a glance.

- Chain lubrication as standard
- All VARIANT balers feature permanent chain lubrication
- Easy adjustment
- Prolongs the service life of the TSUBAKI chains



# Whatever it takes – CLAAS Service & Parts.



CLAAS Service & Parts is always there for you, 24/7. [service.claas.com](http://service.claas.com)



Scan me.



### Specially matched to your machine.

Precision-manufactured parts, high-quality consumables and useful accessories. Choose our comprehensive product range to be certain of receiving exactly the right solution to ensure 100% operational reliability for your machine.



### For your business: CLAAS FARM PARTS.

CLAAS FARM PARTS offers one of the most comprehensive ranges of multi-brand parts and accessories for all agricultural applications on your farm.



### Global supply.

The CLAAS Parts Logistics Center in Hamm, Germany, stocks almost 200,000 different parts and has a warehouse area of over 183,000 m<sup>2</sup>. This central spare parts warehouse delivers all ORIGINAL parts quickly and reliably all over the world. This means that your local CLAAS partner can supply the right solution for your harvest or your business within a very short time.



### Your local CLAAS distributor.

Wherever you are, you can count on us to always provide you with the service and the contact persons you need. Your CLAAS partners are on hand in your local area, ready to support you and your machine around the clock. With know-how, experience, commitment and the best technical equipment. Whatever it takes.



Drive safely, stop safely.

CLAAS offers two different brake systems – a pneumatic and a hydraulic brake – for all drivers who cover long distances on the road between fields, who work on sloping terrain or who want to adapt the permissible driving speed of the VARIANT to the capabilities of their tractor. Availability depends on in-country requirements. Included with all brake systems: an easy-to-operate parking brake.

Easy on the ground: large tyres.

Five different types of large tyre equipment are available for maximum soil protection, even in damp conditions. These tyres also impress with their smooth running.

Greater safety, thanks to the optional brake axle.

The optionally available brake axle ensures safe driving on the road at high speeds. It also makes work on slopes safer. With the pneumatic brake, the VARIANT reaches a top speed of 50 km/h.



At a glance.

- Equipped with pneumatic or hydraulic braking system, depending on the region
- Large tyres for a high level of soil protection
- Optional brake axle for safe transport even at high speeds



560/45 - 22.5

500/45 - 22.5

500/50 - 17

480/45 - 17

380/55 - 17

VARIANT		585 RC PRO	565 RC PRO	580 RF / RC	560 RF / RC
<b>Attachment</b>					
PTO shaft speed	rpm	1000	1000	540 (1000 ○)	540 (1000 ○)
Power requirement	kW / hp	75 / 102	75 / 102	75 / 102	75 / 102
Main drive and drive chains		Heavy-Duty, 1 ¼"	Heavy-Duty, 1 ¼"	Standard, 1"	Standard, 1"
Ball hitch		○	○	○	○
<b>Hydraulic connection</b>					
Single-acting spool valve for pick-up lift		●	●	●	●
Double-acting spool valve for tailgate rams		●	●	●	●
Additional double-acting spool valve for PRO cutting frame		●	●	○	○
<b>Pick-up</b>					
Width	m	2.10 (2.35 ○)	2.10 (2.35 ○)	2.10 (2.35 ○)	2.10 (2.35 ○)
DIN pick-up width	m	1.90 (2.15 ○)	1.90 (2.15 ○)	1.90 (2.15 ○)	1.90 (2.15 ○)
Ground adaptation with 2 fixed guide wheels		●	●	●	●
Ground adaptation with 2 castor guide wheels		○	○	○	○
Ground adaptation with 2 folding castor guide wheels		○	○	○	○
Roller crop press		○	○	○	○
Double roller crop press		○	○	○	○
Pick-up wheels 16/6.50-8 10 PR		●	●	●	●
<b>Crop feed</b>					
Forced feed with		Heavy Duty ROTO CUT	Heavy Duty ROTO CUT	ROTO FEED / ROTO CUT	ROTO FEED / ROTO CUT
Number of knives (with ROTO CUT)		17	17	14	14
Hydraulically lowerable PRO cutting frame		○	○	○	○
<b>Variable bale chamber</b>					
High-strength endless belts	Qty.	4	4	4	4
Belt speed	m/s	3	3	3	3
Soft-core device, pressure and diameter adjustable		●	●	●	●
Supplementary belt drive		●	●	●	●
Moisture sensor		○	○	○	○
SMART DENSITY		●	●	●	●
<b>Bale chamber dimensions</b>					
Width	m	1.20	1.20	1.20	1.20
Diameter	m	0.90-1.80	0.90-1.60	0.90-1.80	0.90-1.60
<b>Operation</b>					
CEMIS 700		●	●	●	●
ISOBUS cables		○	○	○	○
Camera		○	○	○	○
Service lights		○	○	○	○
Central chain lubrication		●	●	●	●
Manual individual lubrication		●	●	●	●
Manual central lubrication		○	○	○	○
Automatic, electric central lubrication		○	○	○	○

VARIANT		585 RC PRO	565 RC PRO	580 RF / RC	560 RF / RC
<b>Wrapping</b>					
NEW: guide plate		●	●	●	●
Net wrapping with automatic start		●	●	●	●
Dual twine wrapping with automatic start		○	○	○	○
CLAAS Covered XW net wrapping		●	●	●	●
Number of twine wraps, selectable		10 settings	10 settings	10 settings	10 settings
Comfort tying (number of net wraps can be adjusted from the cab)		●	●	●	●
Number of twine wraps, selectable		1.6 to 6	1.6 to 6	1.6 to 6	1.6 to 6
<b>Tyres</b>					
380/55-17		●	●	●	●
480/45-17		○	○	○	○
500/50-17 F+		○	○	○	○
500/45-22.5		○	○	○	○
560/45-22.5		○	○	○	○
Air brakes		○	○	○	○
<b>Dimensions and weights</b>					
Length with bale ramp	m	4.82	4.82	4.82	4.82
Width with 380/55-17 tyres	m	2.59	2.59	2.59	2.59
Width with 480/45-17 tyres	m	2.66	2.66	2.66	2.66
Width with 500/50-17 F+ tyres	m	2.67	2.67	2.67	2.67
Width with 500/45-22.5 tyres	m	2.67	2.67	2.67	2.67
Width with 560/45-22.5 tyres	m	2.99	2.99	2.99	2.99
Height	m	3.21-3.26	3.08-3.11	3.21-3.26	3.08-3.11
Minimum weight (depending on specification)	kg	3340	3285	3060	3005
Maximum weight (depending on specification)	kg	4025	3970	3935	3880

CLAAS continually develops its products to meet customer requirements. This means that all products are subject to change without notice. All descriptions and specifications in this brochure should be considered approximate and may include optional equipment that is not part of the standard specifications. This brochure is designed for worldwide use. Please refer to your nearest CLAAS dealer and their price list for local specification details. Some protective panels may have been removed for photographic purposes in order to present functions clearly. To avoid any risk of danger, never remove these protective panels yourself. In this respect, please refer to the relevant instructions in the operator's manual.

● standard ○ optional – unavailable



CLAAS UK  
Saxham  
Bury St. Edmunds  
Suffolk  
IP28 6QZ  
Tel 01284 763100  
claas.co.uk  
info-uk@claas.com

365FarmNet enables you to manage your entire agricultural business by means of a single, non-proprietary software solution. Interfaces to intelligent applications created by partners in the agricultural sector offer expert support for your business 365 days a year.

CLAAS is a 365FarmNet partner.

[www.365farmnet.com](http://www.365farmnet.com)



365FarmNet